

EN



Movement by Perfection



The Royal League in ventilation, control and drive technology

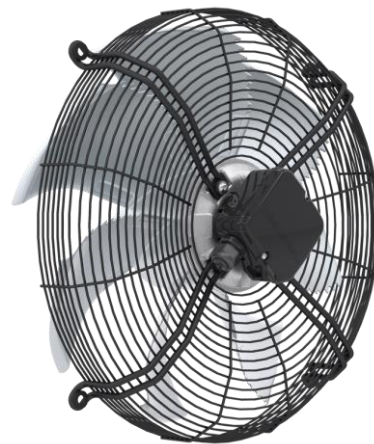

[Product documentation](#)

Type
[FN056-6EK.4I.V7P2](#)

Article number
[167573](#)

Article number
167573

The Royal League

Die Königsklasse

Product documentation

ZIEHL-ABEGG Subsidiary
Headquarters ZIEHL-ABEGG SE
Heinz-Ziehl-Straße
74653 Künzelsau
Tel. +49 7940 16-0
Fax +49 7940 16-300
info@ziehl-abegg.de
www.ziehl-abegg.de

Type
FN056-6EK.4I.V7P2

Article number
167573

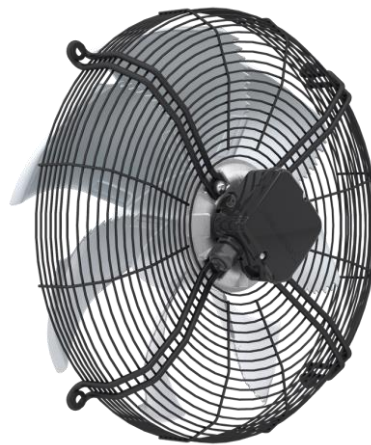

Table of Contents

1.	Product Specification - Technical Data	4
2.	Duty Point Data	5
3.	Characteristic Curve	6
4.	Drawing	7
5.	Connection Diagram	8
6.	Deviation List	9

1. Product Specification - Technical Data

Article number	167573
Type	FN056-6EK.4I.V7P2
Rated values	1~230V 50Hz P(1) 0.39kW 1.8A $\Delta I=15\%$ 910/min 8.0uF/400V 70°C 1~230V 60Hz P(1) 0.58kW 2.6A $\Delta I=0\%$ 980/min 8.0uF/400V 70°C 60Hz
Electrical connection	Terminal box K62
ErP Data	Measurement category ErP: A Air flow q(v) on Eta opt: 5310 m3/h Pressure increase p(fs) on Eta opt: 82 Pa Input power P(1) on Eta opt: 376 W Efficiency H(statA): 33.0 % Efficiency grade: N(actual) = 42.0 / N(target) = 40* *ErP 2015
Type Of Protection	IP54
Heat Class	THCL155
Mounting Type Terminal Box	Mounted on Stator
Connection Diagram	1360-104XA
Rating Plate	1x fixed
Fitting Position	H/Vu/Vo
Motor Protection	thermal contact
Impregnation	Moisture and hot climate protection
Condensation Drain Holes	Condensation drain holes stator/rotor open
Bearing Quality	ball bearing with long-time lubrication
Material Rotor	Aluminium
Painting Rotor	Rotor unpainted
Painting Stator	Stator unpainted
Material Blades	Aluminium
Painting Impeller	Blades unpainted
Contact Protection Type	ring grill
Operating Manual	L-BAL-001
Engine Suspension Paint	Motor suspension powder-coated resistance class 2 (L-TI-0585)
Weight	13.30 kg
Colour Suspension	RAL 9005 (jet black)
Min. Operating Temperature °C	-25°C
Disclaimer Ct20/DoE	Selected product is not governed by U.S. DOE and CT20 industrial fan and blower regulations.

2. Duty Point Data

FN056-6EK.4I.V7P2 (167573)

Design Fan Size Motor Brand		V-K 560 FE2owlet
SFP Class SFP Value (Pspf)	- wspm3	0,0
FEI FEG		0,0
Actual FEP Reference FEP		
Airflow (qV) Airflow Mains	m ³ /h	0,0 0,0
Pressure, stat. (psF) Static Pressure Mains	Pa	0,0 0,0
Dynamic Pressure	Pa	0,0
Total Pressure (pF)	Pa	0,0
Air Velocity	m/s	0,0
Density	kg/m ³	1,17
Altitude		
Temperature	celsius	20
RPM (n) RPM Percentage max.(nmax)	1/min	0,0 @ % 910
Absorbed Power (Psys)	W	0,0
Elec. Power	W	0,0
Shaft Power	W	0,0
System Efficiency, stat. (η _{SF,sys}) tot. (η _{F,sys})	%	0,0 0,0
Eta ERP ERP Year		42,0 2015
Frequency	Hz	50
Voltage	V	
Current	A	0,0
Suction Acoustics (L _{w(A),5}) (L _{w,5})	dB(A)	0 0
Pressure Acoustics (L _{w(A),6}) (L _{w,6})	dB(A)	0 0
Enclosure / Impeller		
Dimensions (Width x Height x Depth)	mm	725 x 725 x 226
Installation (Width x Height x Depth)	mm	x x
Mass	kg	13,3
Kfactor Kfactor Grille		
Nozzle Pressure (psF Düse)	Pa	0,0
Guard Grille		

Full Octave band

f [Hz]	sum	63	125	250	500	1000	2000	4000	8000	f [Hz]	sum	63	125	250	500	1000	2000	4000	8000
L _{w,5}	0	0								L _{w,6}	0	0							
L _{w(A),5}	0	0								L _{w(A),6}	0	0							

3. Characteristic Curve

Measured in full nozzle without guard grille in air flow direction V in installation type A according to ISO5801

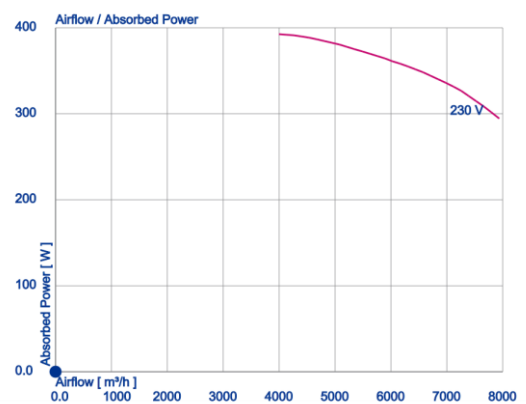
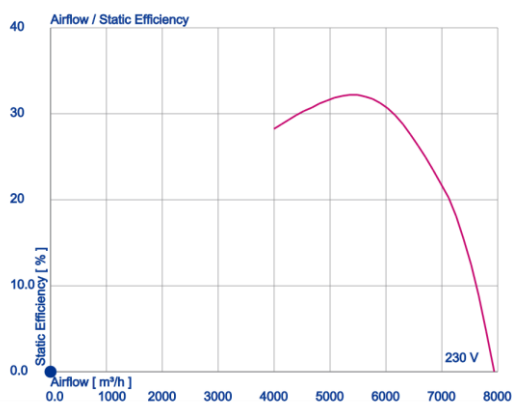
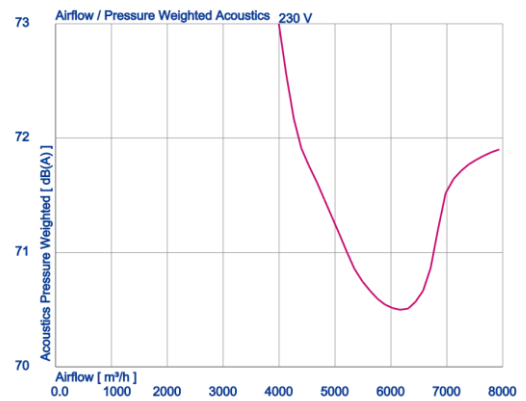
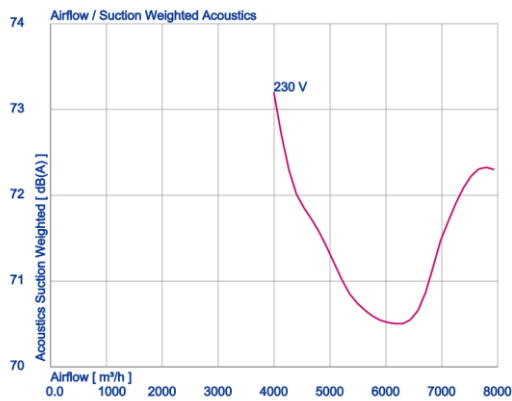
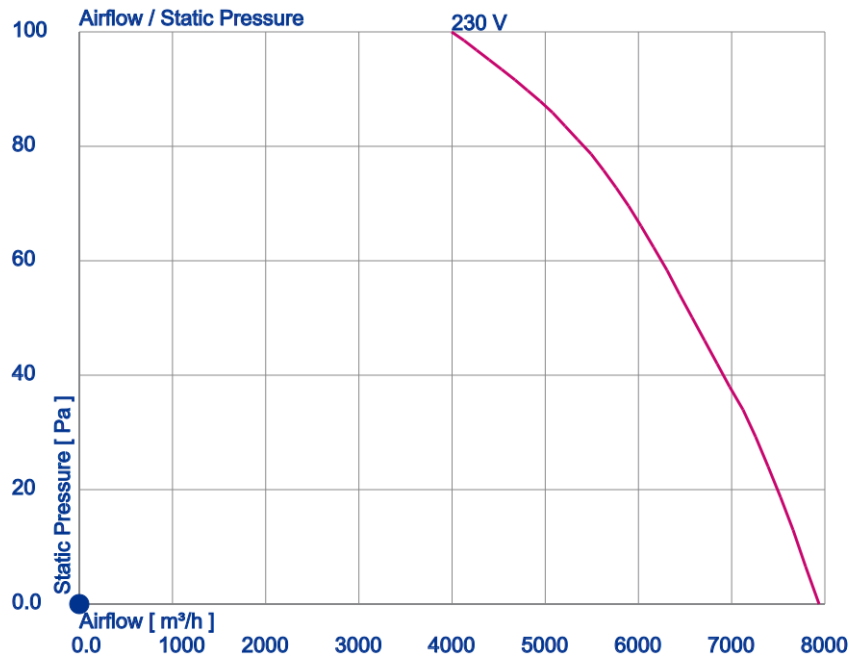

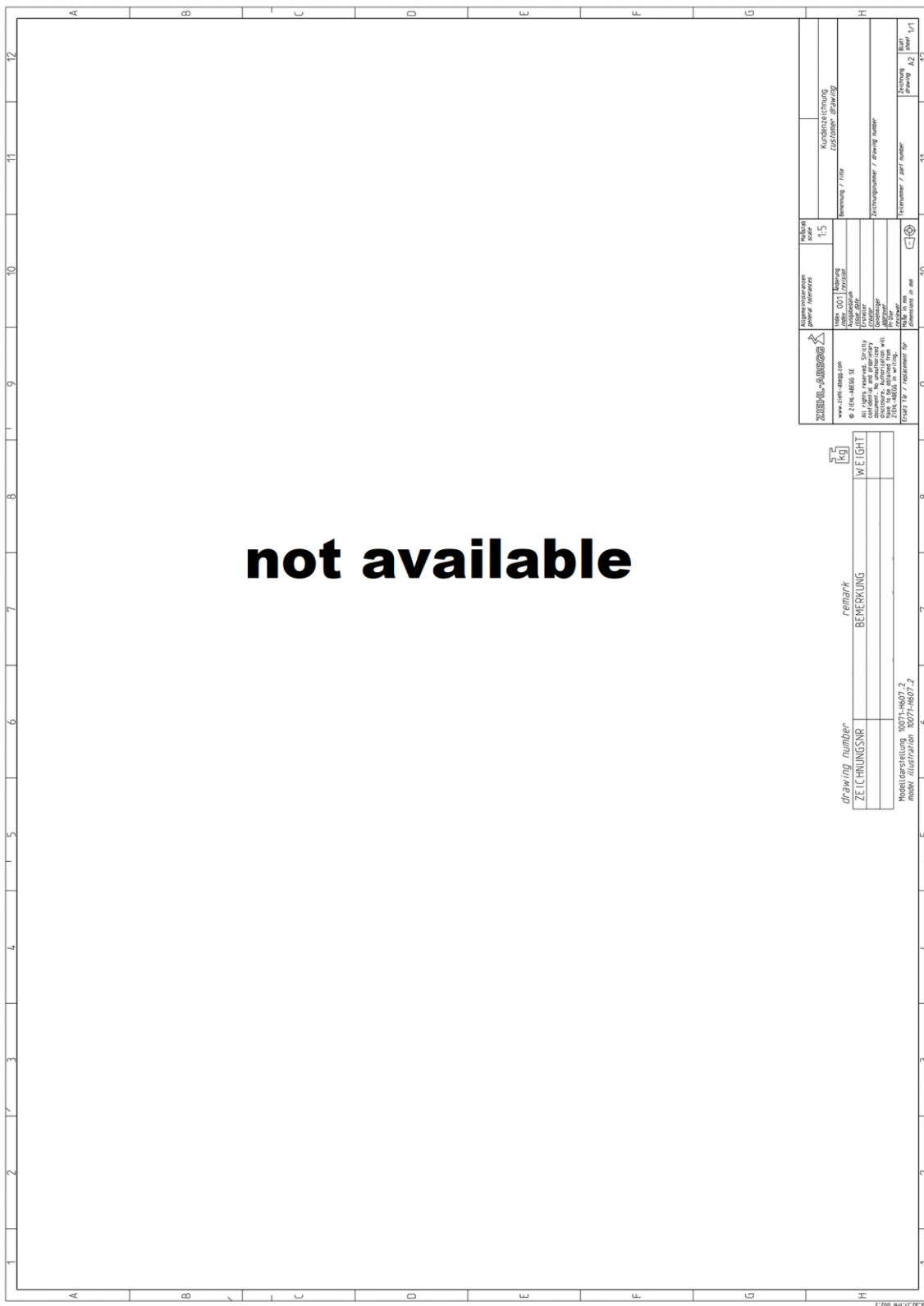

Dimensions in mm

The illustrations shown make no claim to completeness and are for orientation purposes only.

5. Connection Diagram

1~ Motor mit Kondensator und
Thermostatschalter (falls eingebaut).

1~ motor with capacitor and
thermostatic switch (if built in).

104XA-05

Rechtslauf Clockwise rotation

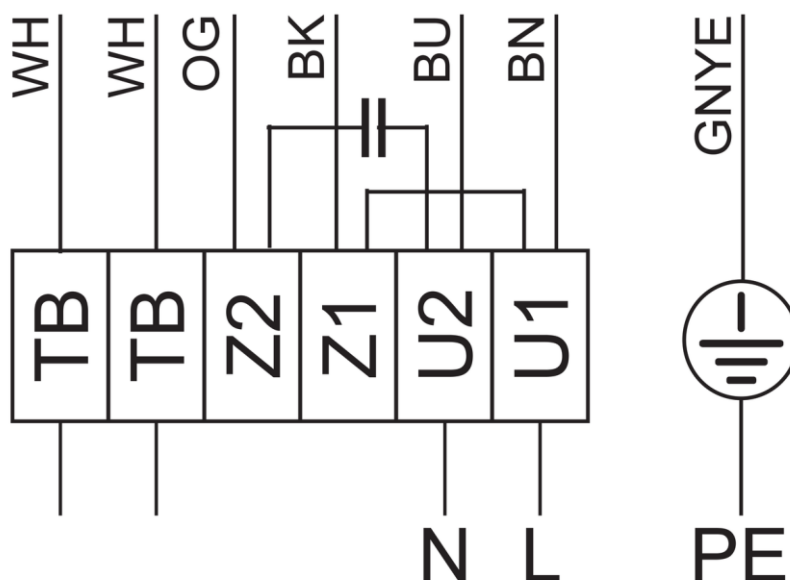

- WH - weiß, white
- OG - orange, orange
- BK - schwarz, black
- BU - blau, blue
- BN - braun, brown
- GNYE - grün-gelb, green-yellow

6. Deviation List

No customer specification was available. Please note that ZIEHL-ABEGG does not confirm technical requirements beyond this specification if they are not listed in a list of deviations. ZIEHL-ABEGG can therefore neither guarantee nor prove the suitability of this product for this specific application or the customer's intended use. The customer is responsible for testing and approving the product for its intended use.



The Royal League in ventilation, **control** and drive technology

Intelligent control technology for any application

ZIEHL-ABEGG system capabilities:

Everything from a single source – perfectly matched for optimal performance

Please contact us. We would be pleased to design an individual solution for your requirements.

We would like to welcome you on our worldwide exhibitions. Please find our next exhibitions here.

[ZIEHL-ABEGG EVENTS](#)