

Date 16/3/2026
 For the attention of:
 Reference
 Operator



COMMERCIAL UNIT COOLER:CUBIC

Type: F27HC 92 E 7 CO2 DX

Spec. CO2 - DX

N. units: 1

Refriger (u) 2026 Ver. 2.4.3.413 - PRICE LIST 1/06/2025

Inlet air temp. (room)	[°C]		2,0
Room relative humidity	[%]		85
Refrigerant			CO2
Altitude	[m]		0
Residual static pressure	[Pa]		0
DT1 needed for unit cooler	[K]		10,0
Connection		230V-1PH-50Hz	
Actual capacity	[W]		7.800
Air flow	[m3/h]		4.000,0
Air throw	[m]		17
Outlet air temperature	[°C]		-2,0
Evaporating temp	[°C]		-8,0
DT superheating	[K]		5,0
Temp. before expansion valve	[°C]		5,0
DT1	[K]		10,0
DTmlg	[K]		7,8
Fluid pressure drop	[K]		1,2
RC factor (Sensible capacity/Total capacity)	[%]		71,6
Fan motor consumpt.	[W]		340
Power draw	[A]		2,4
Max fan absorbed current*	[A]		2,44
Fan speed	[1/min]		1450
Sound pressure level (5 m) 5	[dB(A)@5m]		43
Sound Power Level	[dB(A)]		68
Electric defrost (230 V)	[W]		4.000
N° Fans	[mm]	4 x 275	Weight [kg] 32
Poles	[n]	4	Connections in [n] x [mm] 1 x 12
Fin spacing	[mm]	7	Connections out [n] x [mm] 1 x 16
Internal volume	[dm3]	4,3	Drain tray connection ["] 3/4
Surface	[m2]	19,6	Overall dimensions [mm] 1.788 x 330 x 415
Max Working pressure	[bar]	60,0	
Casing material	Powder coated galvanized steel RAL 9003		Fin material Al
Header material	Cu		Tube material Cu

* Refer to LU-VE S.p.A. instruction manuals for details, data and standards. Noise level in 5m free field. The current may increase according to temperature frost quantity, external static pressure. The weight and dimensions are not valid for all possible configurations. All fans are ErP 2015-compliant (Directive 2009/125/EC Energy-related products). LU-VE S.p.A. reserves the right to modify and correct at any time, with or without notice, the specifications and prices listed in the Refriger software. For products manufactured in the Russian Federation please contact the sales office. Specification related to ventilator voltage (Volt), current (Ampere), electrical power (kW) are available [here](#). The specification is related to a single ventilator.
 EUROVENT – CERTIFY ALL! Eurovent certification guarantees thermal performance, sound specifications, electrical power consumption, air volume flows. The certified performances and conditions in this software are in line with performances and conditions published on EUROVENT website.
 LU-VE Group participates in the ECP programme for HE. Check ongoing validity of certificate and performance on www.eurovent-certification.com.
 The EUROVENT certification refers to the unit in standard configuration, additional options may impact on declared reference performance.

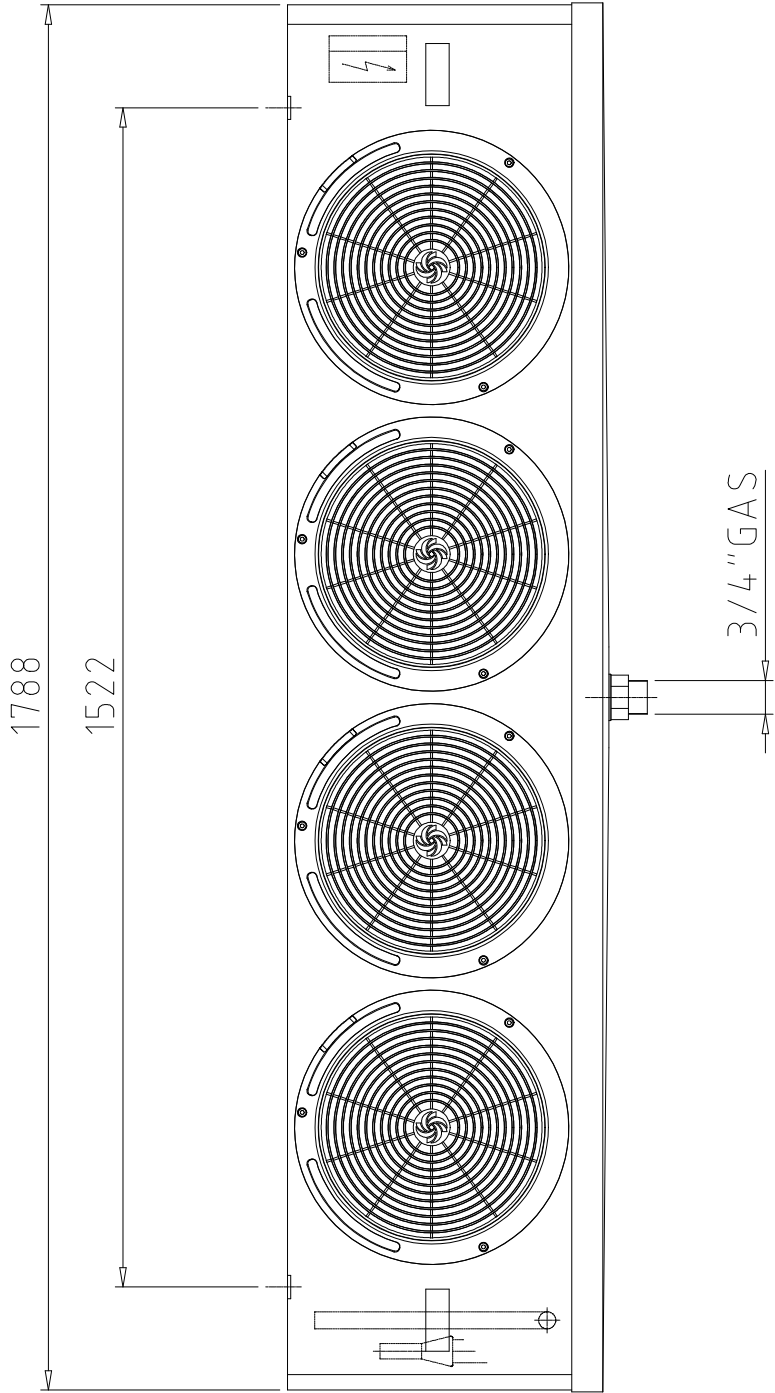
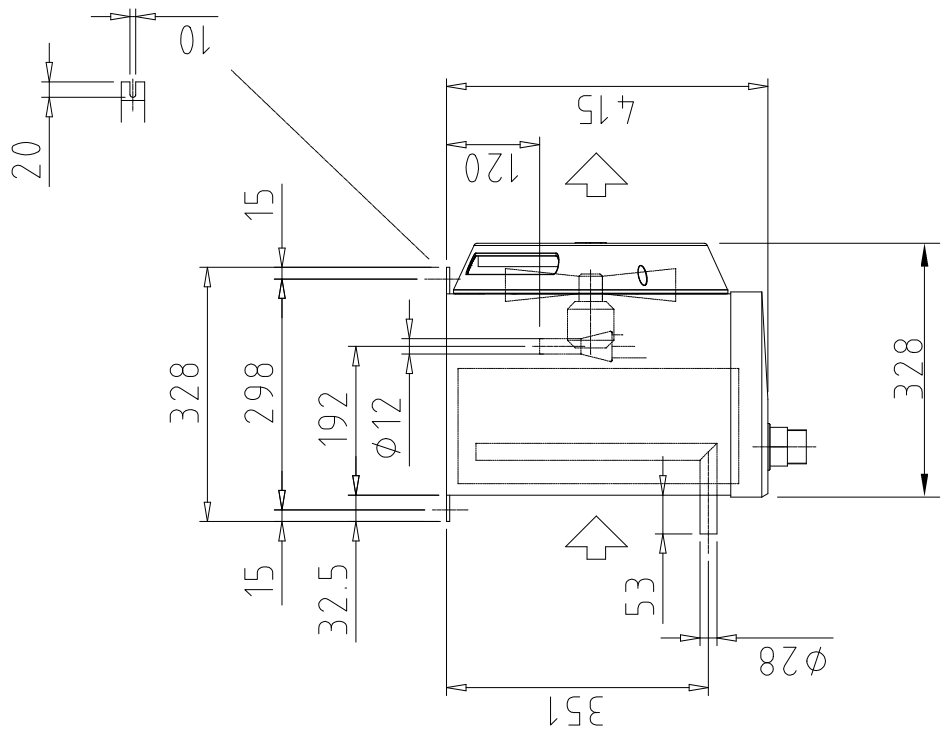

Date	2-3-2008
Scale	1:1

Type: F27HC 92 E 7 C02 DX
 Code: 10113540

LU.VE

Standard unit without accessories. For the connections please refer to the data sheet.