

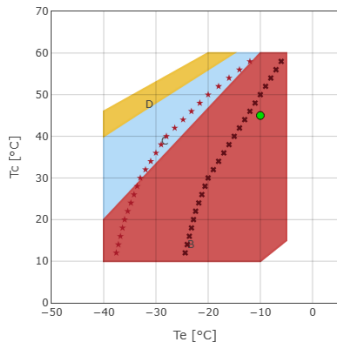

Calculation - H

Input

Model	H1501CS
Refrigerant	R449A
Evaporating temperature	-10.0 °C
Condensing temperature	45.0 °C
Reference temperature	Dew temperature
Suction temperature	20.0 °C
Evaporator outlet temperature	20.0 °C
Liquid subcooling	0.0 K
Voltage / phases / frequency	380-420 V / 3 / 50 Hz
Capacity control system	100%



- B = Standard application
- C = Head cooling fan or max superheating 20K
- D = Head cooling fan + max superheating 20K
- x = Min T_e 50%
- * = Min T_e 50% Head cooling fan or max superheating 20K
- = Dew temperature



Performance calculation

	Standard conditions	At evaporator	At compressor
Cooling capacity	28500 W	28500 W	28500 W
Absorbed power	11.81 kW	11.81 kW	11.81 kW
Condenser capacity	40.31 kW	40.31 kW	40.31 kW
COP	2.41	2.41	2.41
Mass flow	649.1 kg/h	649.1 kg/h	649.1 kg/h
Absorbed current	20.3 A	20.3 A	20.3 A
Discharge temperature	98.0 °C	98.0 °C	98.0 °C
Max operating current	28.0 A	28.0 A	28.0 A
Locked rotor current	134.7 A	134.7 A	134.7 A



Technical data

No. cylinders	4.0	
Bore	68.0	[mm]
Stroke	45.0	[mm]
Displacement @ 50 Hz	56.87	[m ³ /h]
Displacement @ 60 Hz	68.25	[m ³ /h]
Suction valve	35 s.	[mm]
Discharge valve	28 s.	[mm]
Oil charge	2.5	[L]
Net weight	127.0	[kg]

Overall dimensions [mm]

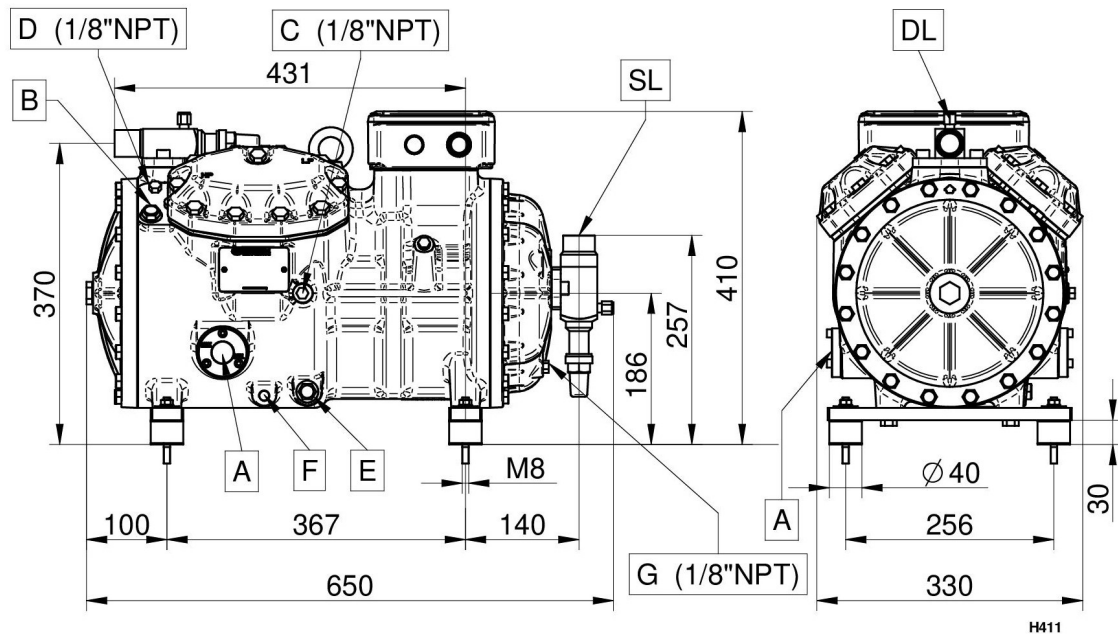

A - Oil sight glass

B - Oil charge plug

C - Low pressure connection

D - High pressure connection

E - Oil drain plug

F - Crankcase heater

DL - Discharge service valve

SL - Suction service valve



Configuration: Standard \ Optional

TE=Thermistor protection	Standard
REL=Motor protection electronic module	Standard
CH=Crankcase heater	Optional
TCH=Self-regulated crankcase heater	Optional
SLCR=Stepless capacity regulator	Optional
BF=Head cooling fan	Optional
WH=Water cooled head	Optional
US=Unloaded start by-pass	Optional
ALL=Oil level warning device	Optional
IP65=Electrical box IP65	Standard
CR1=Capacity control 50-100%	Optional
UL=UL approved compressor	Optional
For operation with HFC refrigerants the compressor must be ordered with POE OIL. For operation with HCFC refrigerant the compressor shall be ordered with mineral oil.	
HFC (POE 46) - HCFC (MIN 46-68)	Standard
For low temperature application external cooling must be provided.	
Motors suitable for operation at different voltage from those listed above may be supplied on request.	
220-240/3/50 (Δ) 380-420/3/50 (Y)	Optional
265-290/3/60 (Δ) 440-480/3/60 (Y)	Optional
380-420/3/50 (PWS) 440-480/3/60 (PWS)	Standard
208-230/3/60 (Δ) 360-400/3/60 (Y)	Optional
208-230/3/60 (PWS)	Optional
220-240/3/50 (PWS)	Optional
360-400/3/60 (PWS)	Optional
475-525/3/50 (PWS) 570-630/3/60 (PWS)	Optional