

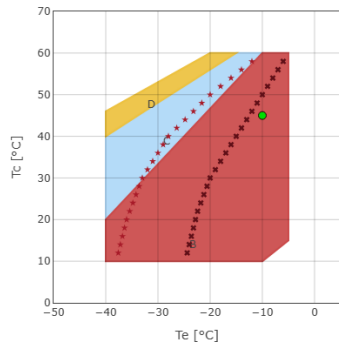

Calculation - H

Input

Model	H801CS
Refrigerant	R449A
Evaporating temperature	-10.0 °C
Condensing temperature	45.0 °C
Reference temperature	Dew temperature
Suction temperature	20.0 °C
Evaporator outlet temperature	20.0 °C
Liquid subcooling	0.0 K
Voltage / phases / frequency	380-420 V / 3 / 50 Hz
Capacity control system	100%



- B = Standard application
- C = Head cooling fan or max superheating 20K
- D = Head cooling fan + max superheating 20K
- x = Min T_e 50%
- * = Min T_e 50% Head cooling fan or max superheating 20K
- = Dew temperature



Performance calculation

	Standard conditions	At evaporator	At compressor
Cooling capacity	20900 W	20900 W	20900 W
Absorbed power	8.56 kW	8.56 kW	8.56 kW
Condenser capacity	29.46 kW	29.46 kW	29.46 kW
COP	2.44	2.44	2.44
Mass flow	475.9 kg/h	475.9 kg/h	475.9 kg/h
Absorbed current	14.8 A	14.8 A	14.8 A
Discharge temperature	98.0 °C	98.0 °C	98.0 °C
Max operating current	19.5 A	19.5 A	19.5 A
Locked rotor current	86.0 A	86.0 A	86.0 A



Technical data

No. cylinders	4.0	
Bore	61.0	[mm]
Stroke	43.0	[mm]
Displacement @ 50 Hz	43.73	[m ³ /h]
Displacement @ 60 Hz	52.48	[m ³ /h]
Suction valve	35 s.	[mm]
Discharge valve	22 s.	[mm]
Oil charge	2.0	[L]
Net weight	91.0	[kg]

Overall dimensions [mm]

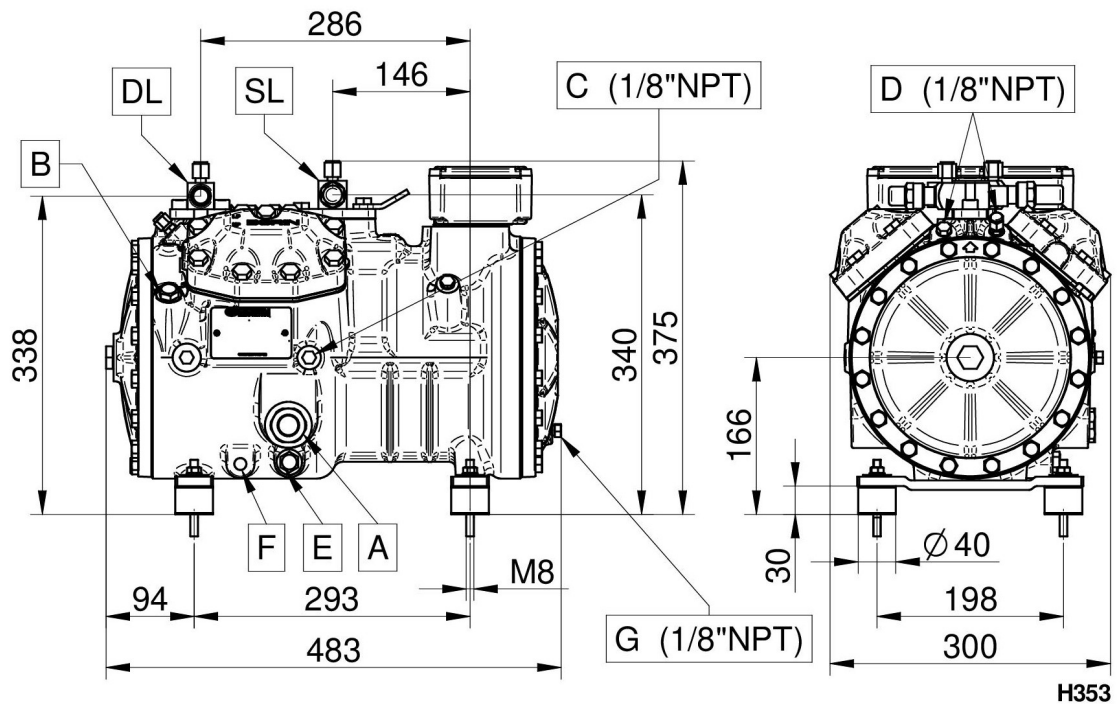

- A - Oil sight glass
- B - Oil charge plug
- C - Low pressure connection
- D - High pressure connection
- E - Oil drain plug
- F - Crankcase heater
- G - Oil return plug
- DL - Discharge service valve
- SL - Suction service valve



Configuration: Standard \ Optional

TE=Thermistor protection	Standard
REL=Motor protection electronic module	Standard
CH=Crankcase heater	Optional
TCH=Self-regulated crankcase heater	Optional
SLCR=Stepless capacity regulator	Optional
BF=Head cooling fan	Optional
WH=Water cooled head	Optional
US=Unloaded start by-pass	Optional
ALL=Oil level warning device	Optional
IP65=Electrical box IP65	Standard
CR1=Capacity control 50-100%	Optional
UL=UL approved compressor	Optional
CB=CB approved compressor	Optional
For operation with HFC refrigerants the compressor must be ordered with POE OIL. For operation with HCFC refrigerant the compressor shall be ordered with mineral oil.	
HFC (POE 46) - HCFC (MIN 46-68)	Standard
For low temperature application external cooling must be provided.	
Motors suitable for operation at different voltage from those listed above may be supplied on request.	
220-240/3/50 (Δ) 380-420/3/50 (Y)	Standard
265-290/3/60 (Δ) 440-480/3/60 (Y)	Optional
475-525/3/50 570-630/3/60	Optional
200/3/50-60 (Δ)	Optional
380-420/3/50 (PWS) 440-480/3/60 (PWS)	Optional
208-230/3/60 (Δ) 360-400/3/60 (Y)	Optional