

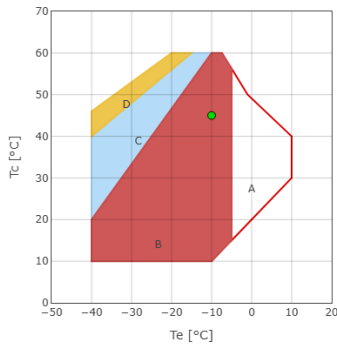

Calculation - H

Input

Model	H151CC
Refrigerant	R449A
Evaporating temperature	-10.0 °C
Condensing temperature	45.0 °C
Reference temperature	Dew temperature
Suction temperature	20.0 °C
Evaporator outlet temperature	20.0 °C
Liquid subcooling	0.0 K
Voltage / phases / frequency	380-420 V / 3 / 50 Hz
Capacity control system	100%



- A = "CC" models only
- B = Standard application
- C = Head cooling fan or max superheating 20K
- D = Head cooling fan + max superheating 20K
- = Dew temperature



Performance calculation

	Standard conditions	At evaporator	At compressor
Cooling capacity	3040 W	3040 W	3040 W
Absorbed power	1.46 kW	1.46 kW	1.46 kW
Condenser capacity	4.49 kW	4.49 kW	4.49 kW
COP	2.08	2.08	2.08
Mass flow	67.6 kg/h	67.6 kg/h	67.6 kg/h
Absorbed current	2.7 A	2.7 A	2.7 A
Discharge temperature	108.9 °C	108.9 °C	108.9 °C
Max operating current	3.4 A	3.4 A	3.4 A
Locked rotor current	15.5 A	15.5 A	15.5 A



Technical data

No. cylinders	2.0	
Bore	38.0	[mm]
Stroke	34.0	[mm]
Displacement @ 50 Hz	6.71	[m ³ /h]
Displacement @ 60 Hz	8.05	[m ³ /h]
Suction valve	16 s.	[mm]
Discharge valve	12 s.	[mm]
Oil charge	1.0	[L]
Net weight	38.0	[kg]

Overall dimensions [mm]

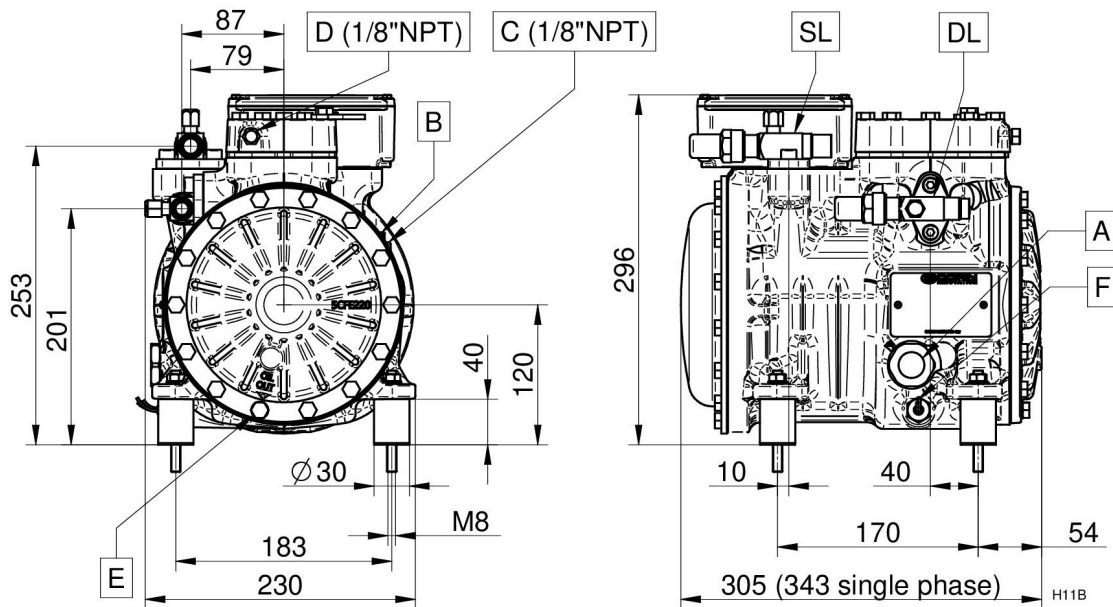

- A - Oil sight glass
- B - Oil charge plug
- C - Low pressure connection
- D - High pressure connection

- E - Oil drain plug
- F - Crankcase heater
- DL - Discharge service valve
- SL - Suction service valve



Configuration: Standard \ Optional

TE=Thermistor protection	Standard
REL=Motor protection electronic module	Standard
CH=Crankcase heater	Optional
TCH=Self-regulated crankcase heater	Optional
BF=Head cooling fan	Optional
WH=Water cooled head	Optional
IP65=Electrical box IP65	Standard
UL=UL approved compressor	Optional
CB=CB approved compressor	Optional
CCC=CCC approved compressor	Optional
For operation with HFC refrigerants the compressor must be ordered with POE OIL. For operation with HCFC refrigerant the compressor shall be ordered with mineral oil.	
HFC (POE 32) - HCFC (MIN 32)	Standard
Motors suitable for operation at different voltage from those listed above may be supplied on request.	
For low temperature application external cooling must be provided.	
220-240/1/50	Optional
220-240/3/50 (Δ) 380-420/3/50 (Y)	Standard
208-230/1/60	Optional
265-290/3/60 (Δ) 440-480/3/60 (Y)	Optional
475-525/3/50 570-630/3/60	Optional
200/3/50-60 (Δ)	Optional
208-230/3/60 (Δ) 360-400/3/60 (Y)	Optional