

Refrigerant	R407C Dew Point
High Side Properties:	
Condensing Temperature, °C	45.00
Abs. Condensing Pressure, bar	17.51
Dew Point, °C	45.00
Bubble Point, °C	40.10
Saturated vapour enthalpy, kJ/kg	425.00
Specific volume of saturated vapour, dm ³ /kg	12.70
Low Side Properties:	
Evaporating Temperature, °C	0.00
Evaporating Abs. Pressure, bar	4.61
Dew Point, °C	0.00
Bubble Point, °C	-6.30
With vapour at, °C	10.00
Specific volume, dm ³ /kg	53.50
Enthalpy, kJ/kg	418.00
Operating Conditions:	
Evaporating Temperature, °C	0.00
Condensing Temperature, °C	45.00
Suction Superheat, K	10.00
Subcooling, K	0.00
Compressor Selected	ZR34K3E-TFD

**PERFORMANCE AT SPECIFIED OPERATING POINT
ZR34K3E-TFD Data at 50 Hz**

Cooling Capacity, kW	6.05
Power, kW	2.07
COP	2.93
Current at 400 V, A	4.07
Suction Mass Flow, g/s	38.40
Heating Capacity, kW	8.01

COMPRESSOR MECHANICAL AND PHYSICAL DATA

Displacement @ 50 Hz, m ³ /h	8.03
Length/Width, mm	246/246
Height, mm	400
Net Weight, kg	28.5
Gross Weight, kg	30
Stub Suction, inch	3/4
Stub Discharge, inch	1/2
Oil Quantity, l	1.24
Oil type (original charge)	POE RL32-3MAF
Oil type (approved oils)	POE RL32-3MAF, POE MOBIL EAL Arctic 22 CC
Base mounting (hole dia), mm	190 x 190 (8.5)
Sound Pressure @ 1m (HT), dBA	57
Sound Power (HT), dBA	68
Sound Power with Sound Shell (HT), dBA	61
Sound Conditions (HT, Temperatures: Evap./Cond./Suction at freq./speed)	7 / 54 / 18 °C at 50 Hz
PED Category	1
Max. Internal Free Volume, l	2.60
High Side PS gauge, bar	29.5
Low Side PS gauge, bar	20
Low Side TS Max., °C	50
Refrigerant's GWP	1774
Refrigerant's classification	A1

COMPRESSOR ELECTRICAL DATA (380-420 V / 3~ / 50 Hz)

Maximum Operating Current, A	6.3
Locked Rotor Current, A	40
Winding Resistance, ohm	4.83
Default Enclosure Class	IP 21 (IEC 34)

ACCESSORIES INCLUDED

Discharge Temperature Protection	Internal Thermodisk
Mounting Grommets	Standard

ACCESSORIES OPTIONAL

Crankcase Heater	70 W External
------------------	---------------

ZR22K3 to ZR40K3

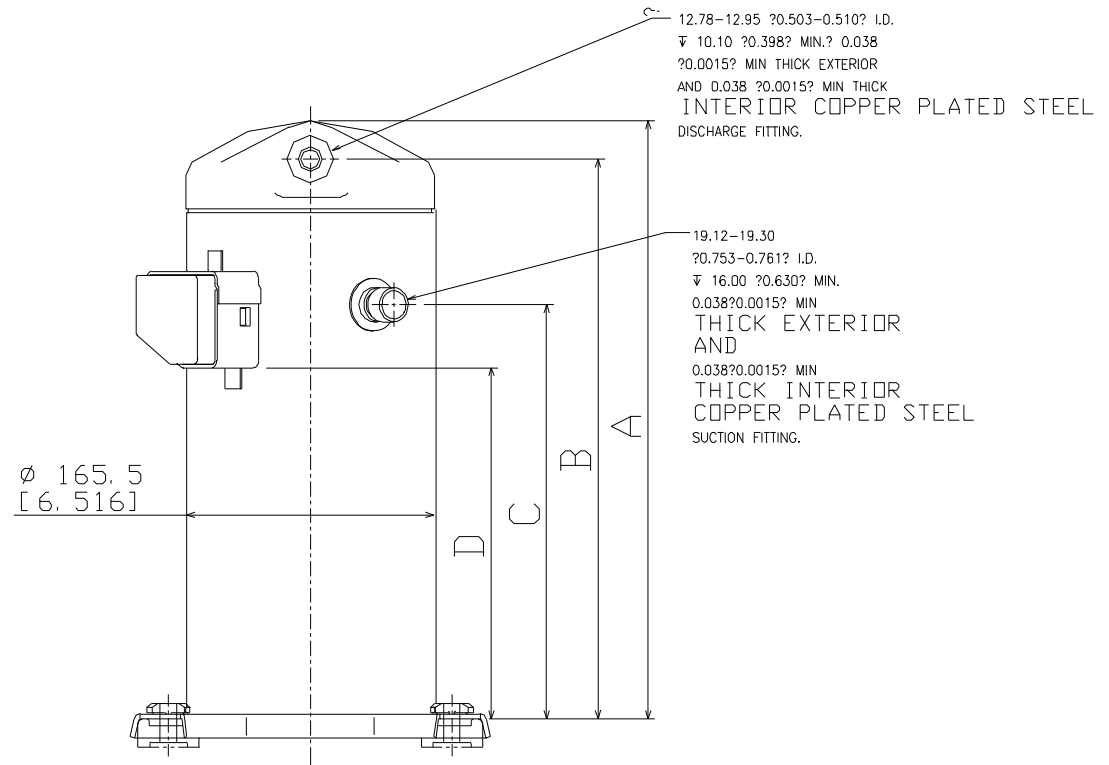
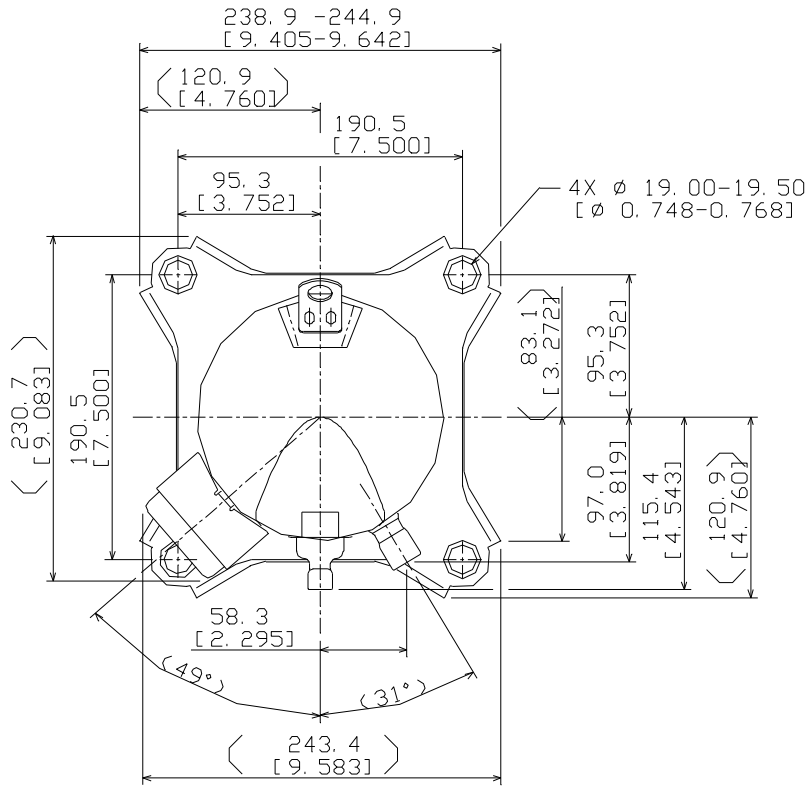

Model	A ±3,0	B	C±3,0	D ±3,0
ZR22 K3 / K3E, ZR28 K3 / K3E	363	338,4	244,6	202,4
ZR34 K3 / K3E	386,5	361,0	264,5	222,3
ZR40 K3 / K3E	400,3	374,8	277,3	235,1